

LD3944A/B Series - 0.39 inch Four Digit 7 Segment LED Display



ATTENTION
OBSERVE PRECAUTIONS
FOR HANDLING
ELECTROSTATIC
DISCHARGE
SENSITIVE
DEVICES



Features

- 10.00 mm (0.39 inch) digit high
- Excellent digit appearance
- Wide viewing angle
- Range of emitted colors
- I.C. compatible
- Low power consumption
- White segment
- RoHS compliant

Available options

- Alternative emitting luminosity:
Standard or high brightness version
- Alternative emitted color
- Alternative segment color
- Alternative font
- Common Cathode is available
- Cropped terminal pins

Package Dimensions

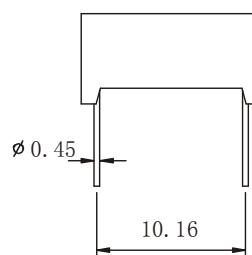
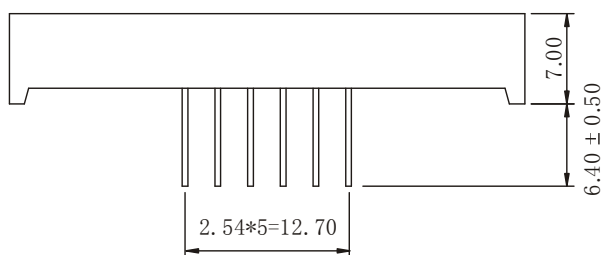
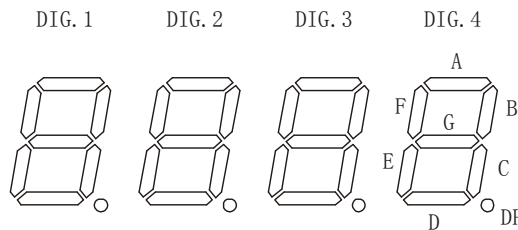
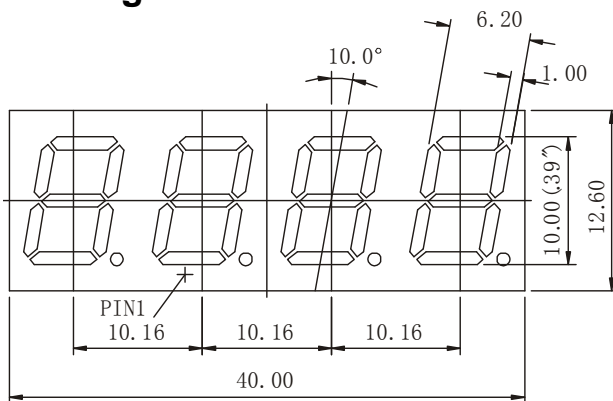

Notes:

1. All dimensions are in millimeters (inches), Tolerance is $\pm 0.25\text{mm}(0.01\text{inch})$ unless otherwise noted.
2. Specifications are subject to change without notice.
3. The gap between the reflector and PCB shall not exceed 0.25mm

-Internal Circuit Diagram

LD3944A (Common Cathode)

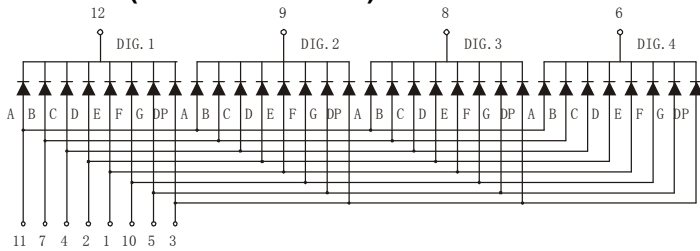

LD3944B (Common Anode)

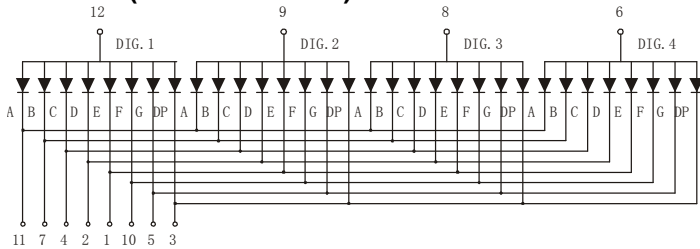

-Selection Guide (Ta = 25 °C)

Four Digit 7 Segment LED Display, Digit Height:10.00mm(0.39 inch), External Dimensions: 40.18x12.80x7.00mm (L x W x H)								
Part No.		Chip			I _v @I _F =20mA		I _v @I _F =20mA	
Common Cathode	Common Anode	Material	Color	WLD	One Seg		One DP	
					Min.	Typ.	Min.	Typ.
LD3944AUR	LD3944BUR	AlGaInP	Ultra Red	640	30	45	30	45
LD3944AUO	LD3944BUO	AlGaInP	Ultra Orange	625	45	60	45	60
LD3944AUA	LD3944BUA	AlGaInP	Ultra Amber	605	30	45	30	45
LD3944AUY	LD3944BUY	AlGaInP	Ultra Yellow	595	30	45	30	45
LD3944AUG	LD3944BUG	AlGaInP	Ultra Green	573	30	45	30	45
LD3944APG	LD3944BPG	InGaN	Pure Green	525	120	300	120	300
LD3944AUB	LD3944BUB	InGaN	Ultra Blue	470	30	45	30	45
LD3944AUW	LD3944BUW	InGaN	Ultra White	\	100	120	100	120
Unit:	\	\	\	nm	mcd	mcd	mcd	mcd

-Electrical Characteristics & Absolute Maximum Ratings

Color		Electrical Characteristics ^[1]			Absolute Maximum Ratings ^[1]		
		Forward Voltage@ IF=20mA		Reverse Current VR=5V	Power Dissipation	DC Forward Current	Peak Forward Current ^[2]
		Typ.	Max.				
Ultra Red	Per Seg.	1.9	2.6	30	60	20	100
	Per DP	1.9	2.6	30	60	20	100
Ultra Orange	Per Seg.	2	2.6	30	65	20	100
	Per DP	2	2.6	30	65	20	100
Ultra Amber	Per Seg.	2	2.6	30	65	20	100
	Per DP	2	2.6	30	65	20	100
Ultra Yellow	Per Seg.	2	2.6	30	65	20	100
	Per DP	2	2.6	30	65	20	100
Ultra Green	Per Seg.	2.1	2.6	30	75	20	100
	Per DP	2.1	2.6	30	75	20	100
Pure Green	Per Seg.	3.0	3.5	30	110	20	100
	Per DP	3.0	3.5	30	110	20	100
Ultra Blue	Per Seg.	3.0	3.5	30	120	20	100
	Per DP	3.0	3.5	30	120	20	100
Ultra White	Per Seg.	3.0	3.5	30	120	20	100
	Per DP	3.0	3.5	30	120	20	100
Unit:	\	V	V	uA	mW	mA	mA

Notes:

1. At Ta = 25 °C.
2. Peak forward current at 1/10 Duty Cycle, 0.1ms Pulse.

Recommended Wave Soldering Profiles:

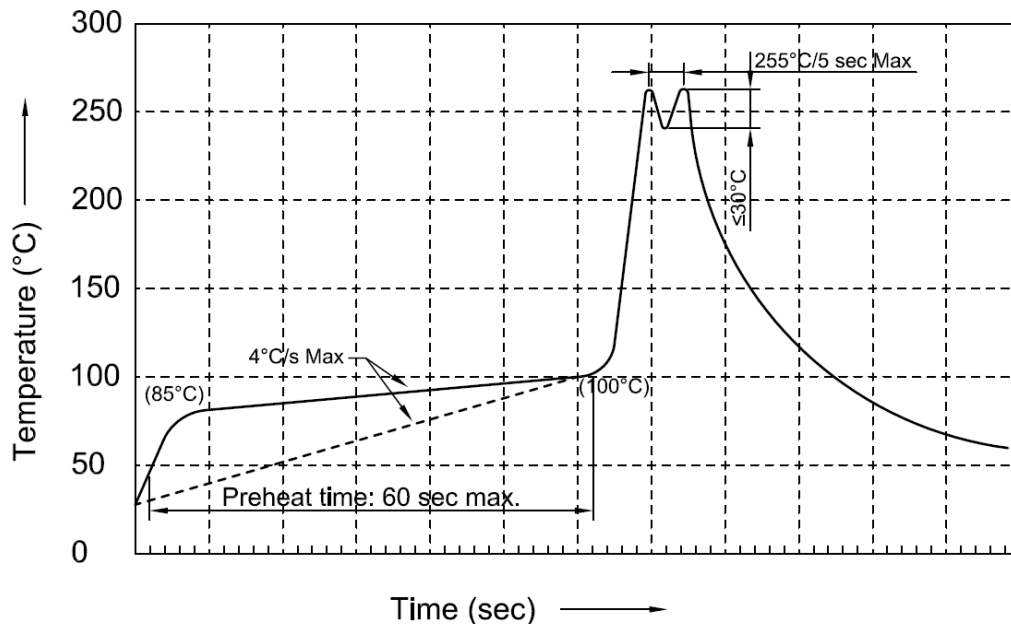

Notes:

1. Recommend pre-heat temperature of 105°C or less (as measured with a thermocouple attached to the LED pins) prior to immersion in the solder wave with a maximum solder bath temperature of 260°C.
2. Peak wave soldering temperature between 245-255°C for 3 sec (5 sec max).
3. Do not apply stress to the epoxy resin while the temperature is above 85°C.
4. Fixtures should not apply stress on the component when mounting and soldering process.
5. More than one wave soldering is not allowed.

Lead Forming

Bend the component leads by hand without proper tools is not allowed. The leads should be bent by clinching the upper part of the lead firmly such that the bending force is not exerted on the plastic body.

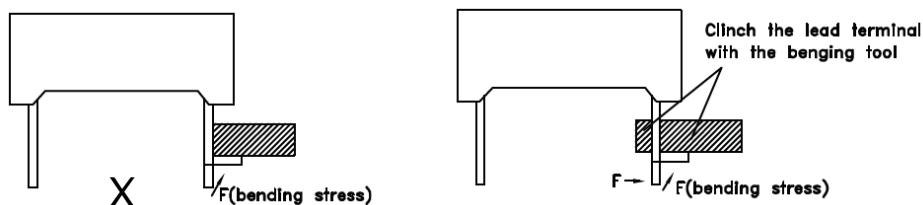

Installation

1. Do not apply stress to the lead terminals.
2. When inserting for assembly, ensure the terminal pitch matches the substrate board's hole pitch to prevent spreading or pinching the lead terminals.



The component shall be placed at least 5mm from edge of PCB to avoid damage caused excessive heat during wave soldering.

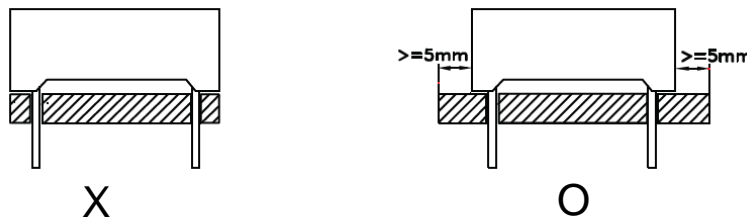

Storage

1. The LEDs should be stored at temp. $\leq 30^{\circ}\text{C}$ & RH. $\leq 70\%$ after being shipped from LITEKEY and the storage life limits are 3 months. If the LEDs are stored for 3 months or more, they can be stored for a year in a sealed container with a nitrogen atmosphere and absorbent material.
2. Please avoid rapid transitions in ambient temperature, especially in high humidity environments where condensation can occur.

Soldering General Notes

1. Through-hole displays are incompatible with reflow soldering.
2. If components will undergo multiple soldering processes where the components may be subjected to intense heat, please check with LITEKEY for compatibility.

Cleaning

1. Mild "no-clean" fluxes are recommended for use in soldering.
2. If cleaning is required, LITEKEY recommends to wash components enclosure with water only. Do not use organic solvents for cleaning, because they may damage the plastic parts. And the devices should not be washed for more than one minute.

-Electrostatic Discharge(ESD)

1. LEDs can be damaged by electrostatic discharge or surge current (EOS).
2. An ESD wrist strap, ESD shoe strap or antistatic gloves must be worn whenever handling LEDs.
3. Grounded properly must be applied for all devices, equipment and machinery.
4. Use ion blower to neutralize the static charge which might have built up on surface of the LEDs plastic lens as a result of friction between LEDs during storage and handling.

-Other

1. Above specification may be changed without notice. LITEKEY will reserve authority on material change for above specification.
2. When using this product, please observe the absolute maximum ratings and the instructions for using outlined in these specification sheets. LITEKEY assumes no responsibility for any damage resulting from use of the product which does not comply with the absolute maximum ratings and the instructions included in these specification sheets.
3. These specification sheets include materials protected under copyright of LITEKEY COMPANY LIMITED. Please don't reproduce cause by anyone to reproduce them without LITEKEY's consent.